

Hex Cap Screw

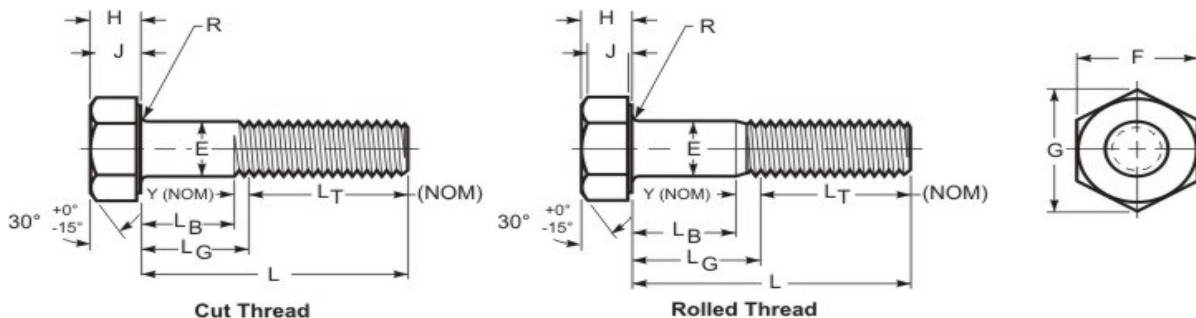

GRADE MARK

THREAD DATA		
Size: 1/4	Threads per in.: 20	Series Designation: UNC
Thread Class or Type: 2A	Major Diameter: 0.2489 - 0.2408	Pitch and Functional Dia.: 0.2164 - 0.2127
Tensile Stress Area: 0.0318	Standard: ASME B1.1 - 2003 (R2008)	
DIMENSIONAL DATA		
Type: Hex Cap Screw	Standard: ASME B18.2.1-2012	Nominal Diameter: 0.25
E - Body Diameter : 0.2500 - 0.2450	F - Width Across Flats: 0.438 - 0.428	G - Width Across Corners: 0.505 - 0.488
R - Fillet Radius: 0.025 - 0.015	H - Head Height: 0.163 - 0.150	J - Wrenching Height Min: 0.106
L _T - Thread Length for Screw Length 6 in. or less: 0.750	Transition Thread Length - Ref.: 0.250	Point Type: Chamfered
Runout of Bearing Surface FIM: 0.010 Max	LG max./LB min.: 1.25/1.00	L - Length: 2
Length Tolerance: -0.04		
PHYSICAL REQUIREMENTS		
Nominal: 0.25	Standard: SAE J429-2014, Grade 5	Typical Materials: medium carbon steel, 1028 through 1055
Hardness: HRC 34 - 25	Proof Load (lbf): 2,700	Tensile Load, Min. (lbf): 3,800
Yield PSI, 2% Offset, Machined Specimen: 92,000	Tensile Strength, Min. (psi): 120,000	Calculated Shear Load-BODY (ref.)(lbf): 2,280
Calculated Shear Load-THREADS (ref.)(lbf): 1,900	Straightness Factor: 0.012	Calculated Pretension ² (lbf) : 2,194
Tightening Torque ¹ : 10 ft.lbf, 121 in.lbf, 13.6 Nm		
FINISH DATA		
Finish: Zinc & Clear, non-hexavalent/Cr(VI) free - .0001"/ 3µm	K factor (ref. DIN 946): 0.22	Standard: ASTM F1941/F1941M-2016, Fe/Zn 3AN

¹ These torque values are based on K factors determined using DIN 946, tightening tension of 75% of the yield strength, and the calculation formula T=KDP. These values are advisory only. The torque for assembling critical joints should be determined and/or verified through actual experimentation by the user. The IFI is not responsible for any losses or claims resulting from the use of these values. ² Calculated Pretension is equal to 75% of the bolt's yield strength achieved when using the indicated Tightening Torque.

