

Hex Cap Screw

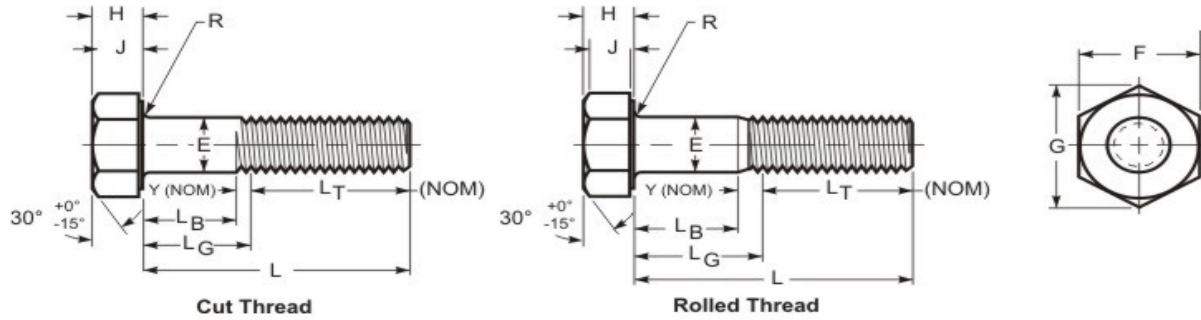

GRADE MARK

THREAD DATA		
Size: 3/8	Threads per in.: 16	Series Designation: UNC
Thread Class or Type: 2A	Major Diameter: 0.3737 - 0.3643	Pitch and Functional Dia.: 0.3331 - 0.3287
Tensile Stress Area: 0.0775	Standard: ASME B1.1 - 2003 (R2008)	
DIMENSIONAL DATA		
Type: Hex Cap Screw	Standard: ASME B18.2.1-2012	Nominal Diameter: 0.375
E - Body Diameter : 0.3750 - 0.3690	F - Width Across Flats: 0.562 - 0.551	G - Width Across Corners: 0.650 - 0.628
R - Fillet Radius: 0.025 - 0.015	H - Head Height: 0.243 - 0.226	J - Wrenching Height Min: 0.160
L _T - Thread Length for Screw Length 6 in. or less: 1.000	Transition Thread Length - Ref.: 0.312	Point Type: Chamfered
Runout of Bearing Surface FIM: 0.012 Max	LG max./LB min.: 2.00/1.69	L - Length: 3
Length Tolerance: -0.06		
PHYSICAL REQUIREMENTS		
Nominal: 0.375	Standard: SAE J429-2014, Grade 5	Typical Materials: medium carbon steel, 1028 through 1055
Hardness: HRC 34 - 25	Proof Load (lbf): 6,600	Tensile Load, Min. (lbf): 9,300
Yield PSI, 2% Offset, Machined Specimen: 92,000	Tensile Strength, Min. (psi): 120,000	Calculated Shear Load-BODY (ref.)(lbf): 5,580
Calculated Shear Load-THREADS (ref.)(lbf): 4,650	Straightness Factor: 0.018	Calculated Pretension ² (lbf) : 5,348
Tightening Torque ¹ : 37 ft.lbf, 441 in.lbf, 49.8 Nm		
FINISH DATA		
Finish: Zinc & Clear, non-hexavalent/Cr(VI) free - .0001"/ 3µm	K factor (ref. DIN 946): 0.22	Standard: ASTM F1941/F1941M-2016, Fe/Zn 3AN

¹ These torque values are based on K factors determined using DIN 946, tightening tension of 75% of the yield strength, and the calculation formula T=KDP. These values are advisory only. The torque for assembling critical joints should be determined and/or verified through actual experimentation by the user. The IFI is not responsible for any losses or claims resulting from the use of these values. ² Calculated Pretension is equal to 75% of the bolt's yield strength achieved when using the indicated Tightening Torque.

