

Round Head- Type III/Sltd Combo (square socket/slot combo)

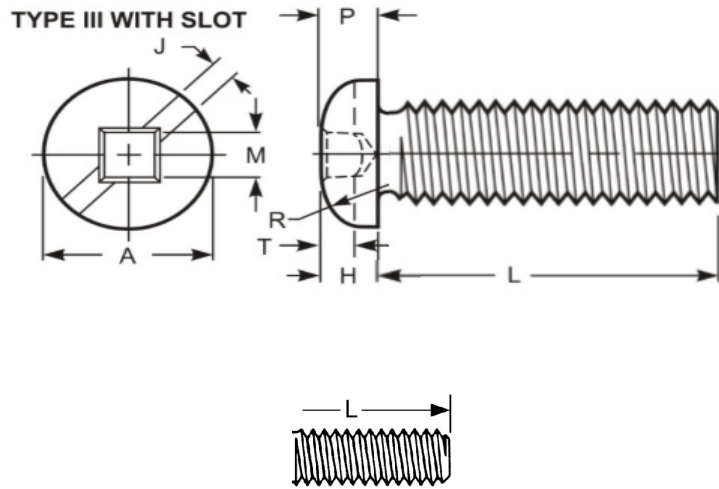

GRADE MARK

THREAD DATA		
Size: 1/4	Threads per in.: 20	Series Designation: UNC
Thread Class or Type: 2A	Major Diameter: 0.2489 - 0.2408	Pitch and Functional Dia.: 0.2164 - 0.2127
Tensile Stress Area: 0.0318	Standard: ASME B1.1 - 2003 (R2008)	
DIMENSIONAL DATA		
Type: Round Head- Type III/Sltd Combo (square socket/slot combo)	Standard: ASME B18.6.3 - 2013	Nominal Diameter: 0.25
A - Head Diameter: 0.472 - 0.443	H - Head Height: 0.175 - 0.160	J - Slot Width: 0.075 - 0.064
T - Slot Depth: 0.109 - 0.082	Driver Size: 3R	Penetration Depth: 0.095 - 0.080
M - Ref. Recess Dim.: 0.133	L - Length: 1-1/2	Length Tolerance: -0.06
PHYSICAL REQUIREMENTS		
Nominal: 0.25	Standard: ASME B18.6.3-2013, Machine Screw (carbon steel)	Typical Materials: low carbon steel, 1010 through 1022
Hardness: HRB 100 - 70	Tensile Load, Min. (lbf): 1,908	Yield PSI, 2% Offset, Machined Specimen: 36,000
Tensile Strength, Min. (psi): 60,000	Calculated Shear Load-BODY (ref.)(lbf): 1,145	Calculated Shear Load-THREADS (ref.)(lbf): 954
Straightness Factor: N/A	Calculated Pretension² (lbf) : 859	Tightening Torque¹ : 4 ft.lbf, 47 in.lbf, 5.3 Nm
FINISH DATA		
Finish: Zinc & Clear, non-hexavalent/Cr(VI) free - .0001"/ 3µm	K factor (ref. DIN 946): 0.22	Standard: ASTM F1941/F1941M-2016, Fe/Zn 3AN

¹ These torque values are based on K factors determined using DIN 946, tightening tension of 75% of the yield strength, and the calculation formula $T=KDP$. These values are advisory only. The torque for assembling critical joints should be determined and/or verified through actual experimentation by the user. The IFI is not responsible for any losses or claims resulting from the use of these values.² Calculated Pretension is equal to 75% of the bolt's yield strength achieved when using the indicated Tightening Torque.

