

Round Head- Type III/Sltd Combo (square socket/slot combo)

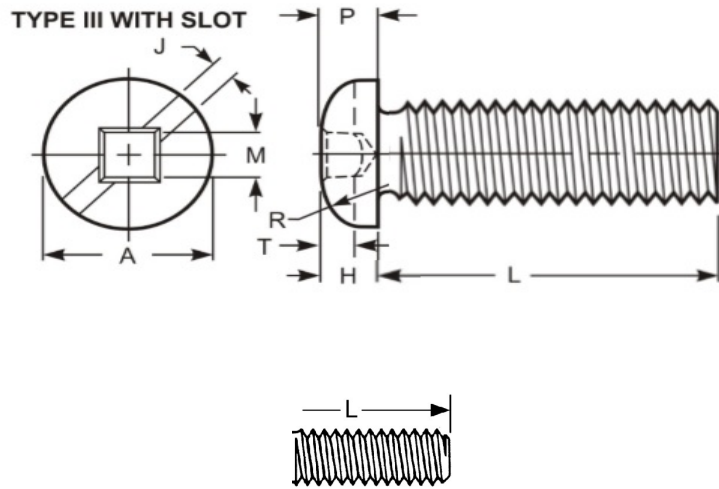

GRADE MARK

THREAD DATA		
Size: #6	Threads per in.: 32	Series Designation: UNC
Thread Class or Type: 2A	Major Diameter: 0.1372 - 0.1312	Pitch and Functional Dia.: 0.1169 - 0.1141
Tensile Stress Area: 0.0091	Standard: ASME B1.1 - 2003 (R2008)	
DIMENSIONAL DATA		
Type: Round Head- Type III/Sltd Combo (square socket/slot combo)	Standard: ASME B18.6.3 - 2013	Nominal Diameter: 0.138
A - Head Diameter: 0.260 - 0.240	H - Head Height: 0.103 - 0.091	J - Slot Width: 0.048 - 0.039
T - Slot Depth: 0.068 - 0.051	Driver Size: 1R	Penetration Depth: 0.065 - 0.050
M - Ref. Recess Dim.: 0.091	L - Length: 1/2	Length Tolerance: -0.02
PHYSICAL REQUIREMENTS		
Nominal: 0.138	Standard: ASME B18.6.3-2013, Machine Screw (carbon steel)	Typical Materials: low carbon steel, 1010 through 1022
Hardness: HRB 100 - 70	Tensile Load, Min. (lbf): 545	Yield PSI, 2% Offset, Machined Specimen: 36,000
Tensile Strength, Min. (psi): 60,000	Calculated Shear Load-BODY (ref.)(lbf): 327	Calculated Shear Load-THREADS (ref.)(lbf): 273
Straightness Factor: N/A	Calculated Pretension² (lbf) : 246	Tightening Torque¹: 1 ft.lbf, 7 in.lbf, 0.8 Nm
FINISH DATA		
Finish: Zinc & Clear, non-hexavalent/Cr(VI) free - .0001"/ 3µm	K factor (ref. DIN 946): 0.22	Standard: ASTM F1941/F1941M-2016, Fe/Zn 3AN

¹ These torque values are based on K factors determined using DIN 946, tightening tension of 75% of the yield strength, and the calculation formula $T=KDP$. These values are advisory only. The torque for assembling critical joints should be determined and/or verified through actual experimentation by the user. The IFI is not responsible for any losses or claims resulting from the use of these values.² Calculated Pretension is equal to 75% of the bolt's yield strength achieved when using the indicated Tightening Torque.

