

Round Head- Type III/Sltd Combo (square socket/slot combo)

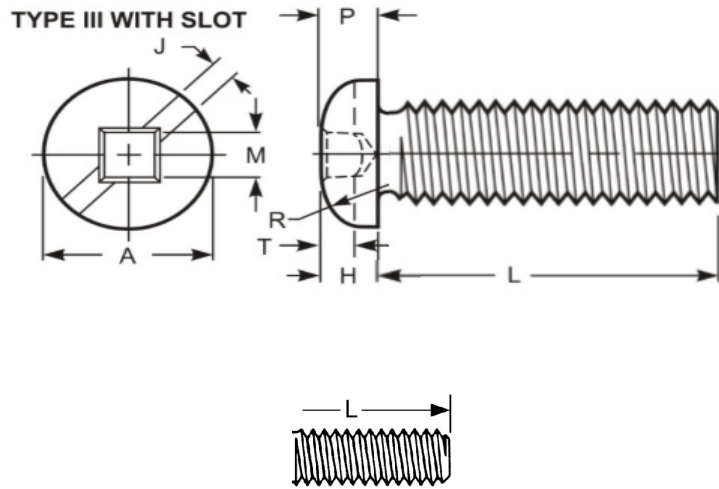

GRADE MARK

THREAD DATA		
Size: #8	Threads per in.: 32	Series Designation: UNC
Thread Class or Type: 2A	Major Diameter: 0.1631 - 0.1571	Pitch and Functional Dia.: 0.1428 - 0.1399
Tensile Stress Area: 0.0140	Standard: ASME B1.1 - 2003 (R2008)	
DIMENSIONAL DATA		
Type: Round Head- Type III/Sltd Combo (square socket/slot combo)	Standard: ASME B18.6.3 - 2013	Nominal Diameter: 0.164
A - Head Diameter: 0.309 - 0.287	H - Head Height: 0.120 - 0.107	J - Slot Width: 0.054 - 0.045
T - Slot Depth: 0.077 - 0.058	Driver Size: 2R	Penetration Depth: 0.075 - 0.060
M - Ref. Recess Dim.: 0.112	L - Length: 3/4	Length Tolerance: -0.03
PHYSICAL REQUIREMENTS		
Nominal: 0.164	Standard: ASME B18.6.3-2013, Machine Screw (carbon steel)	Typical Materials: low carbon steel, 1010 through 1022
Hardness: HRB 100 - 70	Tensile Load, Min. (lbf): 840	Yield PSI, 2% Offset, Machined Specimen: 36,000
Tensile Strength, Min. (psi): 60,000	Calculated Shear Load-BODY (ref.)(lbf): 504	Calculated Shear Load-THREADS (ref.)(lbf): 420
Straightness Factor: N/A	Calculated Pretension² (lbf) : 378	Tightening Torque¹: 1 ft.lbf, 14 in.lbf, 1.5 Nm
FINISH DATA		
Finish: Zinc & Clear, non-hexavalent/Cr(VI) free - .0001"/ 3µm	K factor (ref. DIN 946): 0.22	Standard: ASTM F1941/F1941M-2016, Fe/Zn 3AN

¹ These torque values are based on K factors determined using DIN 946, tightening tension of 75% of the yield strength, and the calculation formula $T=KDP$. These values are advisory only. The torque for assembling critical joints should be determined and/or verified through actual experimentation by the user. The IFI is not responsible for any losses or claims resulting from the use of these values.² Calculated Pretension is equal to 75% of the bolt's yield strength achieved when using the indicated Tightening Torque.

